

JACO² + KG-3

6 DOF

Technical specifications



JACO² 6 DOF no gripper

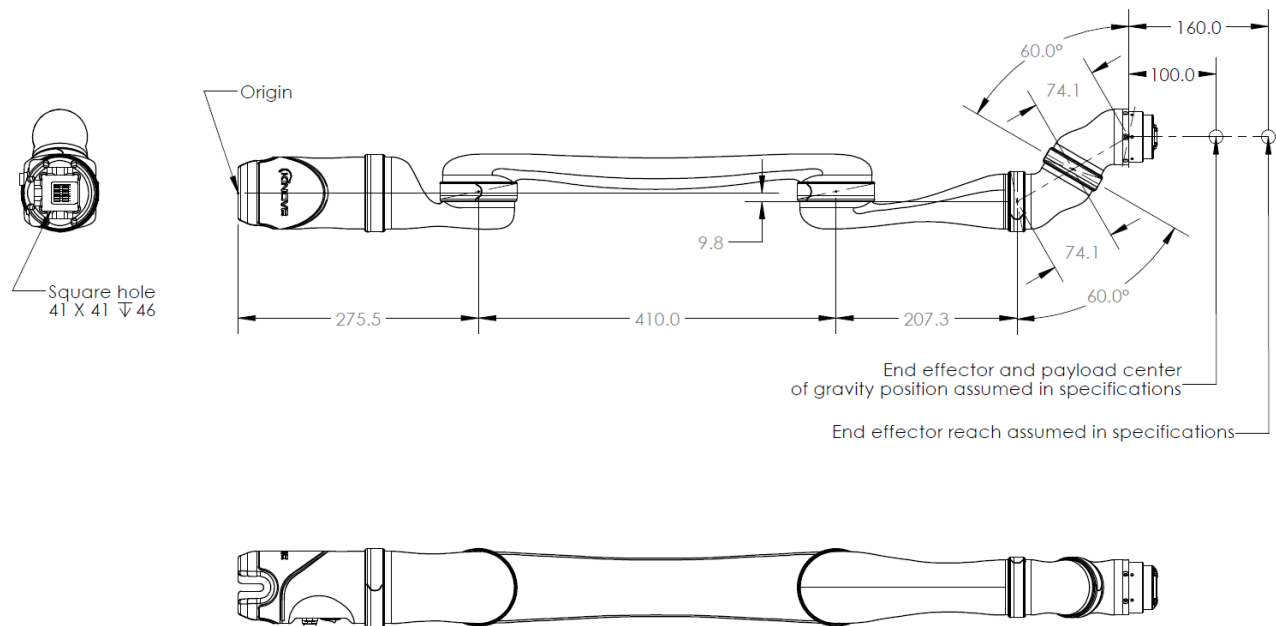

GENERAL

TOTAL WEIGHT	5,2 Kg
MATERIALS	Carbon fiber (links), Aluminum (actuators)
PAYLOAD	1.6 Kg (mid-range continuous payload capabilities) 1.3 Kg (full-reach peak/temporary payload capabilities)
REACH	90 cm
JOINT RANGE AFTER START-UP (SOFTWARE LIMITATION)	±27.7 turns
MAXIMUM LINEAR ARM SPEED	20 cm/s
POWER SUPPLY VOLTAGE	18 to 29 VDC
AVERAGE POWER	25 W (5W in STANDBY)
PEAK POWER	100 W
COMMUNICATION PROTOCOL	RS485
COMMUNICATION CABLES	20 pins flat flex cable
2 EXPANSION PINS ON COMMUNICATION BUS	
WATER RESISTANCE	IPX2
OPERATING TEMPERATURE	-10 °C to 40 °C expected

CONTROLLER

PORTS

Joystick

Power supply

USB 2.0 (API)

Ethernet

1 Mbps CANBUS

18 to 29 VDC

12 Mbps

Not Available

CONTROL SYSTEM FREQUENCY

100 Hz (High Level API)

500 Hz (Low Level API)

CPU

360 MHz

SDK

APIs

High and low level

Compatibility

Windows, Linux Ubuntu & ROS

Port

USB 2.0

Programming languages

C++

FORCE, CARTESIAN & ANGULAR CONTROL

DETAILED SPECIFICATIONS

ACTUATORS #1 & #3

K-75

ACTUATOR #2

K-75+

ACTUATORS #4, #5 & #6

K-58



6110 Doris-Lussier
Boisbriand, QC, Canada
J7H 0E8

Kinovarobotics.com